

Match the net to the correct solid then find the surface area.

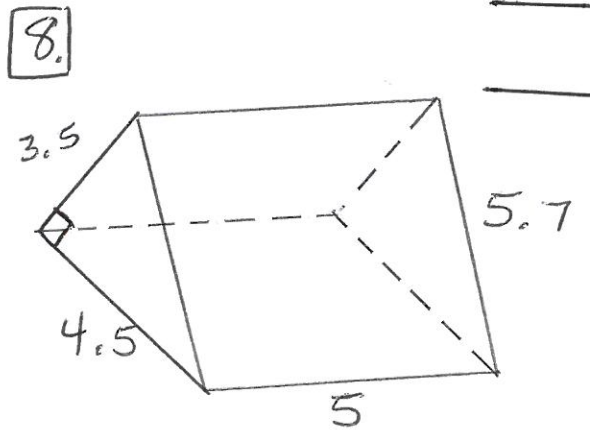

NAME :

A.

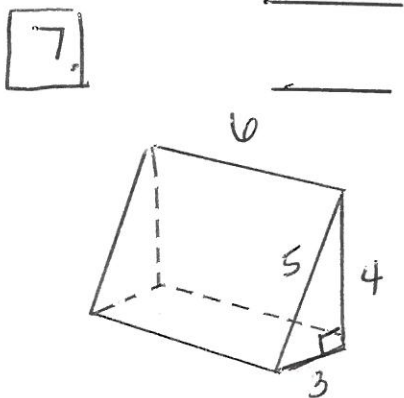
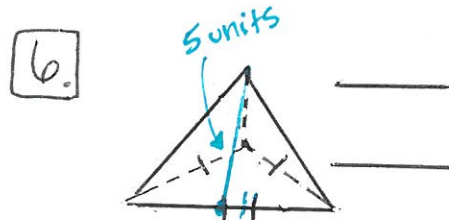
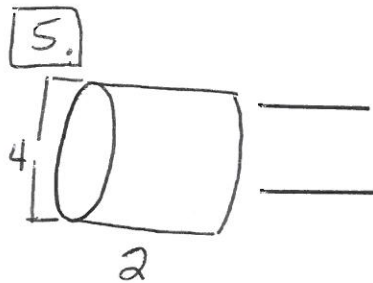
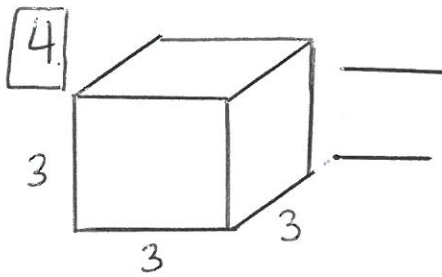
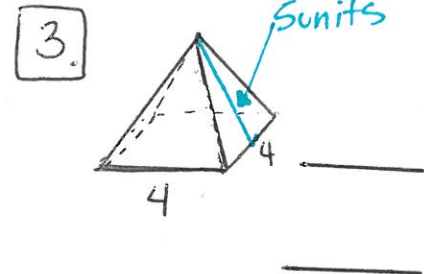
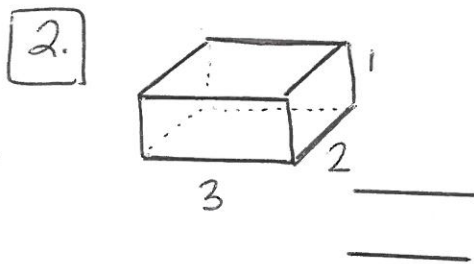
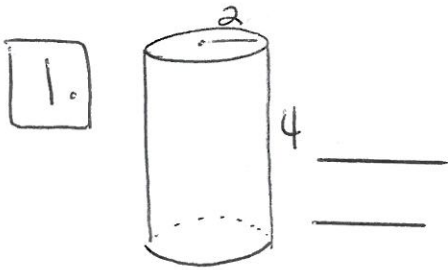
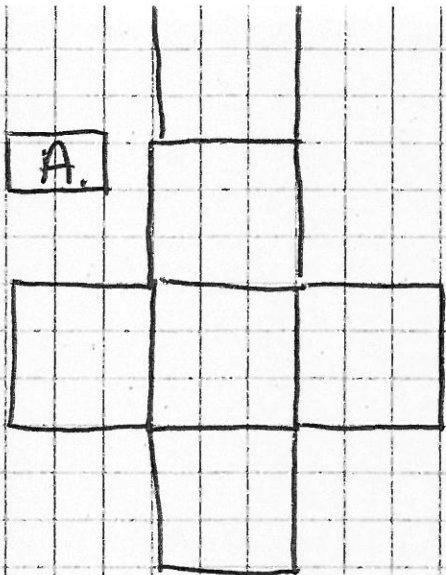

B.

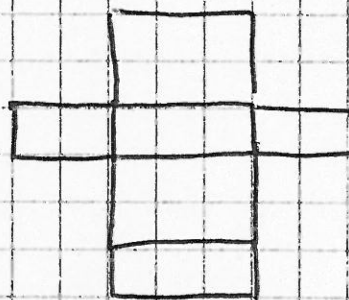

C.

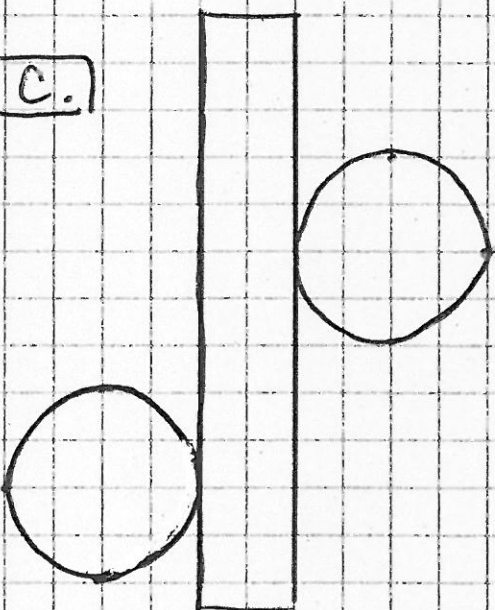

D.

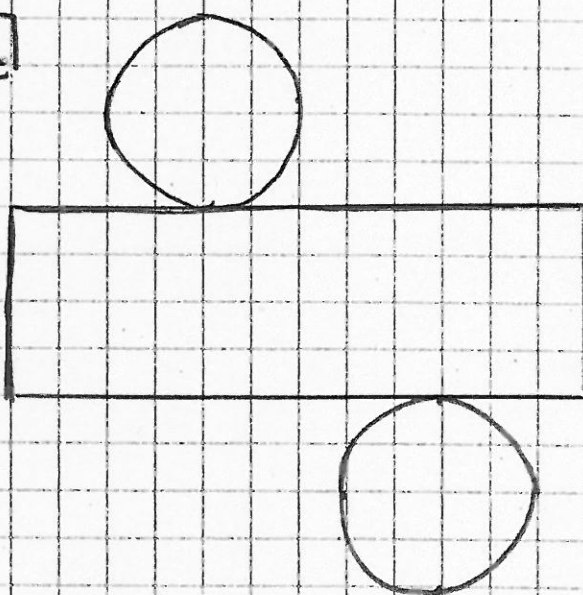

E.

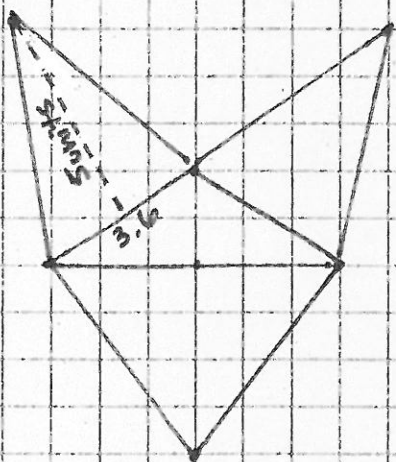

F.

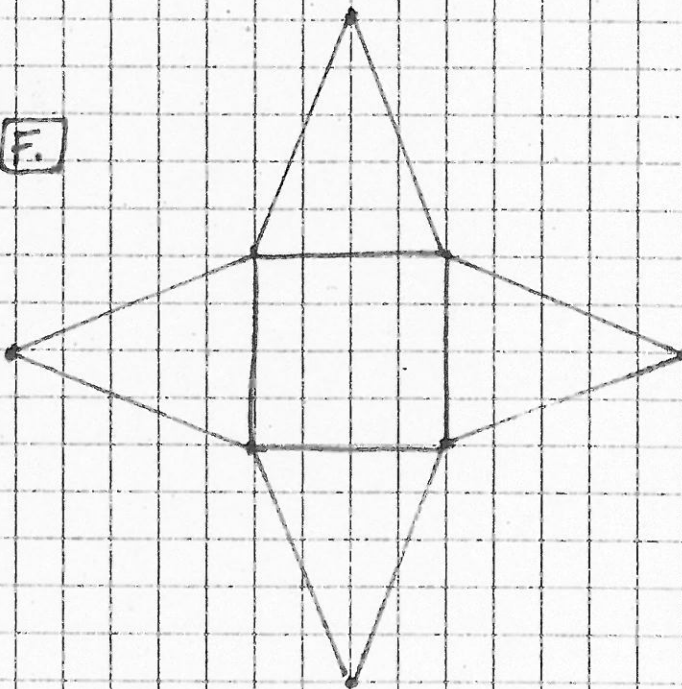

G.

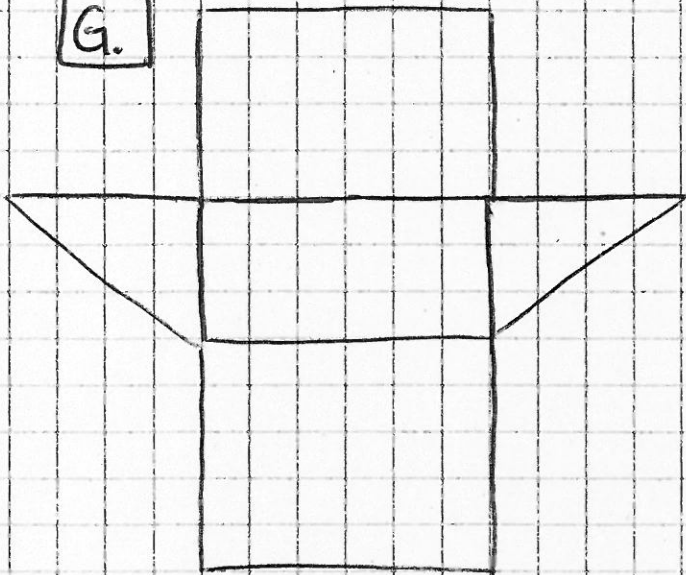

H.

